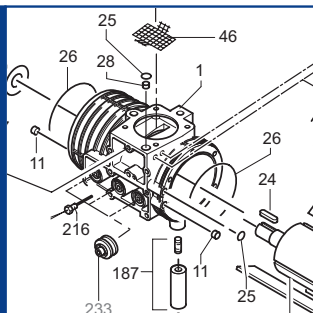

U 4.250

SERVICE

BECKER
D-42279 Wuppertal
www.becker-international.com

year XXXX

No. **H** Index Variante

type **U 4.250-XX**

frequency XXXX Hz

speed XXXX min⁻¹

power required XXXX kW

inlet capacity XXXX m³/h

pressure + XXXX mbar

vacuum - XXXX mbar

Made in Germany

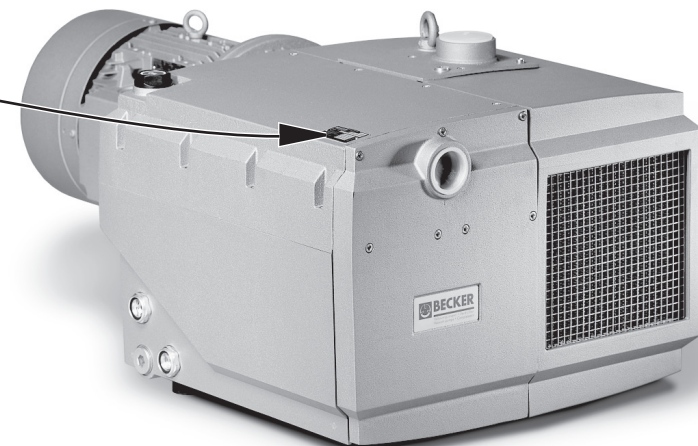

Ersatzteilliste
Spare parts list
Liste de pièces de rechange
Listino pezzi di ricambio
Lista de piezas de recambio
Lista de peças sobresselentes
Reserveonderdelenlijst
Atsarginių dalių sąrašas
Varuosad nimekirja
Rezerves daļu saraksts

Reservdeliste
Reservdelslista
Varaosuettelo
Reservdelsliste
Wykaz części zamiennych
Tartalékalkatrész lista
Seznam náhradních dílů
Seznam nadomestnih delov
Zoznam náhradných dielov
Rezervni dijelovi popis

Lista pieselor de schimb
Páirteanna spártha liosta
Κατάλογος ανταλλακτικών
Yedek parça listesi
Списък на резервните части
Перечень запасных частей
スペアパーツリスト
예비 부품 목록
备用零件目录

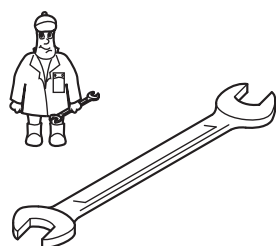

Pos.	Menge ²⁾ Quantity Quantité Quantità Cantidad	Bestell-Nr. Ident No. No. Identification No. Identificazione No. de pedido	Bezeichnung Description Designation Designazione Descripción
□	1	549000 26400	Dichtungssatz, Complete set of seals, Jeu de joints, Kit di guarnizioni, Junta Completa
5	SATZ/KIT	900507 00003	Schieber, Rotor Vane, Palette, Empujador
83	2	965415 00000	Luftentölelement, Oil separating element, Element separation huile, Cartuccia sepa-ratore olio, Elemento de desaceitar de aire

²⁾ erforderliche Bestellmenge / necessary order quantity / quantité nécessaire / quantità di ordinazione necessari / cantidad necesario

Wartung
Maintenance
Entretien
Manutenzione
Mantenimiento



SERVICE
www.becker-international.com
Sales and service network

U 4.250

Standard



Variante



U 4.250/XX

①
U 4.250 F/K

②③
U 4.250 SA/K-25 + F/K-25

④⑤
U 4.250 SA/K-25.1 + F/K-25.1

⑥⑦
U 4.250 SA/K-51 + F/K-51

⑧
U 4.250 SA/K-54

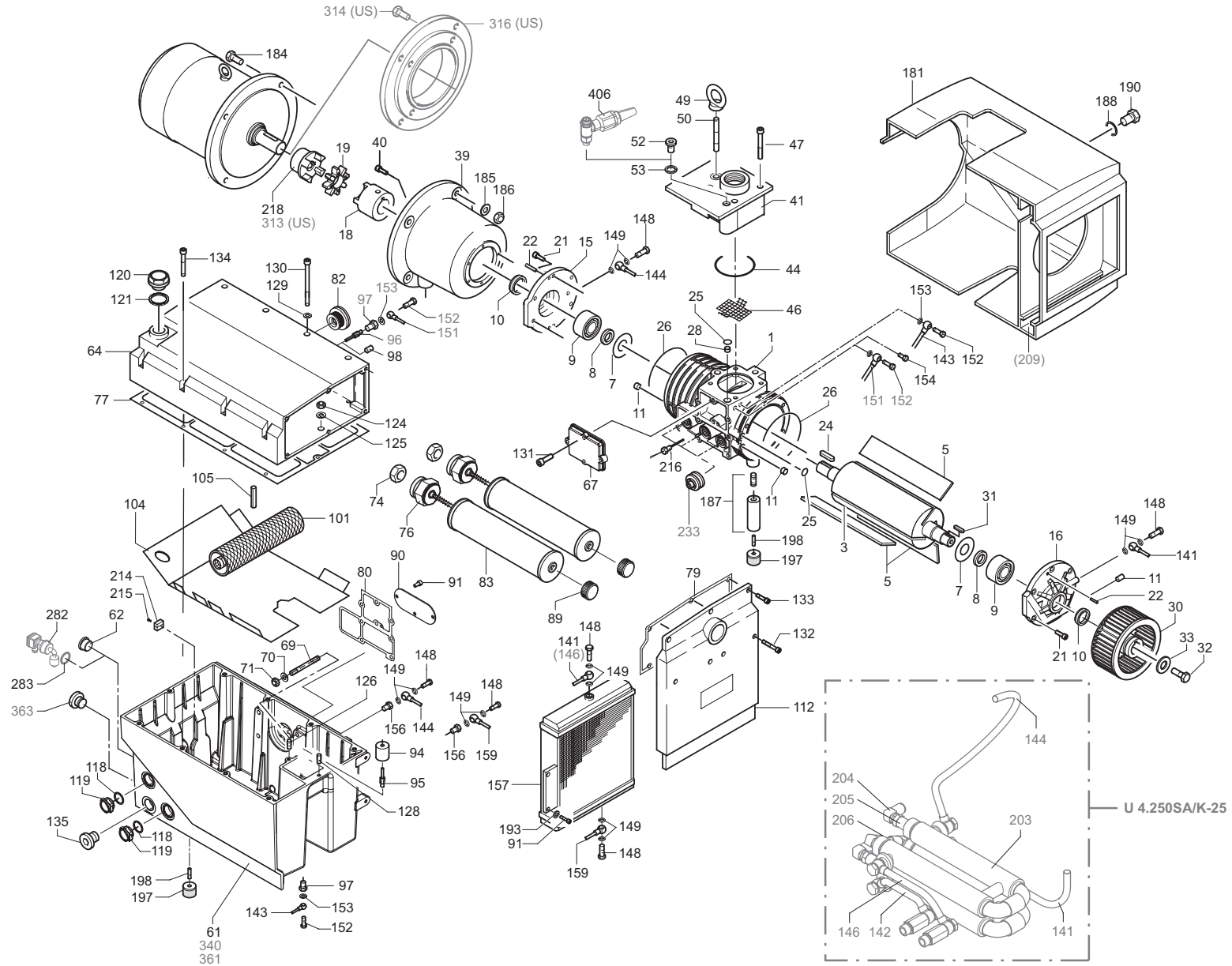

SERVICE ?

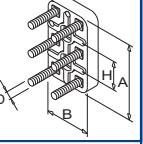
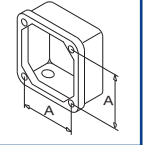
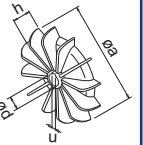
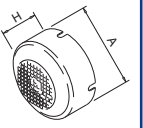
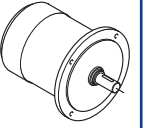



H INDEX	Pos.	Bestell Nr.	Beschreibung	
U 4.250	□	549000 26400	DICHTUNGSSATZ ¹⁾	
	1	000102 26500	GEHÄUSE	
	3	020000 26500	KOLBEN	
	5	900507 00003	SCHIEBER, KUNSTSTOFF (SATZ) ²⁾	
	7	917611 00000	LAGERDICHTRING	
	8	911472 00000	DISTANZSCHEIBE	
	9	906662 00000	WÄLZLAGER 6207 DIN 625	
	10	906576 00000	WELLENDICHTRING	
	11	912820 00000	VERSCHLUSSDECKEL	
	15	000801 26500	SEITENDECKEL	
	16	000702 26500	SEITENDECKEL	
	18	902108 00000	KUPPLUNGSHÄLFTE	
	19	902210 00000	KUPPLUNGSSCHEIBE	
21	945331 00000	INNENSECHSKANTSCHRAUBE		
22	948742 00000	PASSKERBSTIFT		
24	947733 00000	PASSFEDER		
30	502301 26400	VENTILATOR MIT NABE		
31	947732 00000	PASSFEDER		
32	945270 00000	WELLENENDSCHRAUBE		
33	949409 00000	UNTERLEGSCHRAUBE		
39	053200 26500	LATERNE		
40	945321 00000	INNENSECHSKANTSCHRAUBE		
41	537502 26400	RÜCKSCHLAGVENTIL, KOMPL.		
46	008002 26400	SIEB		
47	945371 00000	INNENSECHSKANTSCHRAUBE		
49	951602 00000	RINGMUTTER		
50	946969 00000	STIFTSCHRAUBE		
52	951228 00000	VERSCHLUSS-SCHRAUBE		
61	002410 26400	ABSCHIEDERGEHÄUSE		
62	951221 00100	VERSCHLUSS-SCHRAUBE		
64	001703 26400	ÖLBEHÄLTER-DECKEL		
67	003705 26400	DECKEL		
69	946968 00000	STIFTSCHRAUBE		
70	917107 00000	TELLERFEDER		
71	947105 00000	SECHSKANTMUTTER		
74	305800 02000	ÜBERWURFMUTTER		
76	727505 99628	ABBLASEVENTIL		
82	537502 26200	VENTIL, KOMPL.		
83	965415 00000	LUFTENTÖLELEMENT (2x) ²⁾		
89	921500 50000	HANDGRIFF		
90	013301 26400	PRALLBLECH		
91	945318 00000	INNENSECHSKANTSCHRAUBE		
94	867800 99559	SCHWIMMER		
95	003300 10700	DÜSE		
98	912871 00000	VERSCHLUSS-SCHRAUBE		
101	506000 26400	GROBABSCHIEDER, KOMPLETT		
104	008003 26400	SIEB		
105	952014 00000	SPANNHÜLSE		
112	003703 26400	DECKEL		
119	907309 00000	ÖLSCHAUGLAS		
120	916800 10000	SCHRAUBDECKEL		
124	947104 00000	SECHSKANTMUTTER		
125	948504 00000	FEDERRING		
126	951001 02000	STIFTSCHRAUBE		
128	951003 02000	STIFTSCHRAUBE		
130	945383 00000	INNENSECHSKANTSCHRAUBE		
131	945230 00000	SECHSKANTSCHRAUBE		
132	945363 00000	INNENSECHSKANTSCHRAUBE		
133	945321 00000	INNENSECHSKANTSCHRAUBE		

H INDEX	Pos.	Bestell Nr.	Beschreibung	
	134	945324 00000	INNENSECHSKANTSCHRAUBE	
	135	951220 00100	VERSCHLUSS-SCHRAUBE	
	141	012223 26400	LEITUNG	
	143	012221 26400	ÖLRÜCKFÜHRLEITUNG	
	144	012224 26400	LEITUNG	
	148	948402 00000	HOHLSCHRAUBE	
	152	009400 19000	KUGELSTÜCKSCHRAUBE	
	154	012900 19000	VERSCHLUSS-SCHRAUBE	
	156	912306 00000	ANSCHLUSS-SCHRAUBE	
	157	960201 26400	KÜHLER	
	159	012222 26400	LEITUNG	
	181	018301 26400	HAUBE	
	184	945127 00000	SECHSKANTSCHRAUBE	
	185	947506 00000	UNTERLEGSCHRAUBE	
	186	947106 00000	MUTTER	
	187	568100 26400	STÜTZE	
	188	949408 00000	U-SCHRAUBE	
	190	945227 00000	WELLENABSCHLUSS-SCHRAUBE	
	193	949203 00000	ZAHNSCHRAUBE	
	197	741302 00000	GUMMIPUFFER	
	198	945634 00000	GEWINDESTIFT	
	214	950700 10000	LÜSTERKLEMMEN	
	215	946304 00000	INNENSECHSKANTSCHRAUBE	
	216	943400 90000	TEMPERATURFÜHLER	
	218	902100 21900	MOTORKUPPLUNG Ø38MM	
	282	741103 99682	NIVEAUGEGER - OPTIONAL	
	313	902100 21300	MOTORKUPPLUNG (US)	
	314	945238 00000	SECHSKANTSCHRAUBE (US)	
	316	037900 10400	ZWISCHENFLANSCH (US)	
	406	768705 99626	GASBALLASTVENTIL - OPTIONAL	
		960009 00200	BECKER LUBE M 100 (MINERALÖL) - 5L	
		960016 00200	BECKER LUBE S 100 (SYNTHETIKÖL) - 5L	
		960023 00200	BECKER LUBE SL 100 (LEBENSMITTELBEREICH) - 5L	

¹⁾ Dichtungssatz - 549000 26400 - Pos.: 13, 25, 26, 44, 53, 63, 77, 79, 80, 118, 121, 129, 136, 149, 153, 283

²⁾ erforderliche Bestellmenge / Wartung

H INDEX	Pos.	Ident No.	Description	
U 4.250	□	549000 26400	SET OF SEALS ¹⁾	
	1	000102 26500	PUMP BODY	
	3	020000 26500	ROTOR	
	5	900507 00003	ROTOR VANE IN PLASTIC (KIT) ²⁾	
	7	917611 00000	BEARING SEALING WASHER	
	8	911472 00000	DISTANCE DISC	
	9	906662 00000	BEARING 6207 DIN 625	
	10	906576 00000	SHAFT SEALING RING	
	11	912820 00000	CAP	
	15	000801 26500	LID	
	16	000702 26500	LID	
	18	902108 00000	COUPLING	
	19	902210 00000	COUPLING DISC	
21	945331 00000	SOCKET HEAD SCREW		
22	948742 00000	STRAIGHT PIN		
24	947733 00000	KEY		
30	502301 26400	FAN		
31	947732 00000	KEY		
32	945270 00000	SHAFT END BOLD		
33	949409 00000	WASHER		
39	053200 26500	CONNECTION FLANGE		
40	945321 00000	SOCKET HEAD SCREW		
41	537502 26400	NON RETURN VALVE, ENTIRE		
46	008002 26400	SIEVE		
47	945371 00000	SOCKET HEAD SCREW		
49	951602 00000	RING UNIT		
50	946969 00000	STUD		
52	951228 00000	LOCKING SCREW		
61	002410 26400	HOUSING FOR OIL SEPARATION		
62	951221 00100	LOCKING SCREW		
64	001703 26400	OIL TANK COVER		
67	003705 26400	COVER		
69	946968 00000	STUD		
70	917107 00000	SPRING COLLAR		
71	947105 00000	HEX.NUT		
74	305800 02000	COUPLING NUT		
76	727505 99628	BLOW OFF VALVE		
82	537502 26200	VALVE, ENTIRE		
83	965415 00000	OIL SEPARATION ELEMENT (2x) ²⁾		
89	921500 50000	HANDLE		
90	013301 26400	METAL FILTER		
91	945318 00000	SOCKET HEAD SCREW		
94	867800 99559	FLOAT		
95	003300 10700	NOZZLE		
98	912871 00000	LOCKING SCREW		
101	506000 26400	COARSE SEPARATOR		
104	008003 26400	SIEVE		
105	952014 00000	FIXING SLEEVE		
112	003703 26400	COVER		
119	907309 00000	OIL SIGHT GLASS		
120	916800 10000	COVER		
124	947104 00000	HEX.NUT		
125	948504 00000	SPRING WASHER		
126	951001 02000	STUD		
128	951003 02000	STUD		
130	945383 00000	SOCKET HEAD SCREW		
131	945230 00000	HEX. HEAD SCREW		
132	945363 00000	SOCKET HEAD SCREW		
133	945321 00000	SOCKET HEAD SCREW		

H INDEX	Pos.	Ident No.	Description	
	134	945324 00000	SOCKET HEAD SCREW	
	135	951220 00100	LOCKING SCREW	
	141	012223 26400	PIPE	
	143	012221 26400	OIL RETURN PIPE	
	144	012224 26400	PIPE	
	148	948402 00000	HOLLOW SCREW	
	152	009400 19000	HOLLOW HOLDING SCREW	
	154	012900 19000	LOCKING SCREW	
	156	912306 00000	CONNECTING SCREW	
	157	960201 26400	COOLER	
	159	012222 26400	PIPE	
	181	018301 26400	PROTECTING HOOD	
	184	945127 00000	HEX-HEAD SCREW	
	185	947506 00000	WASHER	
	186	947106 00000	NUT	
	187	568100 26400	SUPPORT PILLAR	
	188	949408 00000	WASHER	
	190	945227 00000	SCREW	
	193	949203 00000	TOOTHED SPRING WASHER	
	197	741302 00000	RUBBER BUFFER	
	198	945634 00000	THREADED PIN	
	214	950700 10000	LUSTER TERMINAL	
	215	946304 00000	SOCKET HEAD SCREW	
	216	943400 90000	TEMPERATURE PROBE	
	218	902100 21900	COUPLING MOTOR SIDE Ø38MM	
	282	741103 99682	OIL LEVEL CONTROL - OPTIONAL	
	313	902100 21300	COUPLING MOTOR SIDE (US)	
	314	945238 00000	HEX-HEAD SCREW (US)	
	316	037900 10400	INTERMEDIATE FLANGE (US)	
	406	768705 99626	GAS BALLAST VALVE - OPTIONAL	
		 960009 00200	BECKER LUBE M 100 (MINERAL OIL) - 5L	
		960016 00200	BECKER LUBE S 100 (SYNTHETIC OIL) - 5L	
		960023 00200	BECKER LUBE SL 100 (FOOD SECTOR) - 5L	

¹⁾ Set of seals - 549000 26400 - Pos.: 13, 25, 26, 44, 53, 63, 77, 79, 80, 118, 121, 129, 136, 149, 153, 283
²⁾ necessary order quantity / maintenance

H INDICE	Pos.	No. Identification	Designation	FR	
U 4.250	■	549000 26400	JEU DE JOINTS ¹⁾		
	1	000102 26500	CORP DE POMPE		
	3	020000 26500	PISTON		
	5	900507 00003	PALETTE ON PLASTIQUE (KIT) ²⁾		
	7	917611 00000	RONDELLE D'ETANCHEITE DU ROULEMENT		
	8	911472 00000	DISQUE AJUSTAGE		
	9	906662 00000	ROULEMENT 6207 DIN 625		
	10	906576 00000	BAGUE D'ETANCHEITE P.L'AXE		
	11	912820 00000	COUVERCLE		
	15	000801 26500	COUVERCLE		
	16	000702 26500	COUVERCLE		
	18	902108 00000	ACCOUPEMENT		
	19	902210 00000	DISQUE D'ACCOUPEMENT		
21	945331 00000	VIS HEXAGONALE INTERNE			
22	948742 00000	GOUPILLE CYLINDRIQUE			
24	947733 00000	CLAVETTE			
30	502301 26400	VENTILATEUR			
31	947732 00000	CLAVETTE			
32	945270 00000	VIS BOUT D'ARBRE			
33	949409 00000	RONDELLE			
39	053200 26500	BRIDE DE RACCORDEMENT			
40	945321 00000	VIS HEXAGONALE INTERNE			
41	537502 26400	SOUPAPE ANTI-RETOUR, ENTIER			
46	008002 26400	FILTRE			
47	945371 00000	VIS HEXAGONALE INTERNE			
49	951602 00000	ECROU A ANNEAU			
50	946969 00000	PRISONNIER			
52	951228 00000	BOUCHON			
61	002410 26400	CORP DE SEPARATEUR D'HUILE			
62	951221 00100	BOUCHON			
64	001703 26400	COUVERCLE RESERVOIR D'HUILE			
67	003705 26400	COUVERCLE			
69	946968 00000	PRISONNIER			
70	917107 00000	RONDELLE À RESSORT			
71	947105 00000	ECROU A 6 PANS			
74	305800 02000	ECROU			
76	727505 99628	SILENCIEUX			
82	537502 26200	SOUPAPE, ENTIER			
83	965415 00000	ELEMENT SEPARATION HUILE (2x) ²⁾			
89	921500 50000	POIGNEE			
90	013301 26400	FILTRE METALIQUE			
91	945318 00000	VIS HEXAGONALE INTERNE			
94	867800 99559	PIED CAOUTCHOVE			
95	003300 10700	GICLEUR			
98	912871 00000	BOUCHON			
101	506000 26400	SEPARATEUR A GROS			
104	008003 26400	FILTRE			
105	952014 00000	MANCHON DE FIXATION			
112	003703 26400	COUVERCLE			
119	907309 00000	VERRE REGARD			
120	916800 10000	COUVERCLE			
124	947104 00000	ECROU A 6PANS			
125	948504 00000	ANNEAU-RESSORT			
126	951001 02000	PRISONNIER			
128	951003 02000	PRISONNIER			
130	945383 00000	VIS HEXAGONALE INTERNE			
131	945230 00000	VIS HEXAGONALE			
132	945363 00000	VIS HEXAGONALE INTERNE			
133	945321 00000	VIS HEXAGONALE INTERNE			

H INDICE	Pos.	No. Identification	Designation	FR	
	134	945324 00000	VIS HEXAGONALE INTERNE		
	135	951220 00100	BOUCHON		
	141	012223 26400	TUYAU		
	143	012221 26400	TUYAU D'HUILE		
	144	012224 26400	TUYAU		
	148	948402 00000	VIS CREUSE		
	152	009400 19000	VIS CREUSE DE FIXATION		
	154	012900 19000	BUCHON		
	156	912306 00000	VIS DE RACCORD		
	157	960201 26400	REFROIDISSEUR		
	159	012222 26400	TUYAU		
	181	018301 26400	CARTER PROTECTEUR		
	184	945127 00000	VIS HEXAGONALE		
	185	947506 00000	RONDELLE		
	186	947106 00000	ECROU		
	187	568100 26400	SUPPORT INTERMEDIAIRE		
	188	949408 00000	RONDELLE		
	190	945227 00000	VIS		
	193	949203 00000	DENT DISQUE		
	197	741302 00000	AMORTISSEUR EN CAOUTCHOUC		
	198	945634 00000	GOUPILLE FILETEE		
	214	950700 10000	SERRE-FILS		
	215	946304 00000	VIS HEXAGONALE INTERNE		
	216	943400 90000	PALPEUR DE TEMPERATURE		
	218	902100 21900	ACCOUPEMENT MOTEUR Ø38MM		
	282	741103 99682	INDICATEUR DE NIVEAU - EN OPTION		
	313	902100 21300	ACCOUPEMENT MOTEUR (US)		
	314	945238 00000	VIS HEXAGONALE (US)		
	316	037900 10400	BRIDE INTERMEDIAIRE (US)		
	406	768705 99626	L'ESTE D'AIR - EN OPTION		
		 960009 00200	BECKER LUBE M 100 (HUILE MINÉRALE) - 5L		
		960016 00200	BECKER LUBE S 100 (L'HUILE SYNTHÉTIQUE) - 5L		
		960023 00200	BECKER LUBE SL 100 (SECTEUR DE L'ALIMENTATION) - 5L		

¹⁾ Jeu de joints - 549000 26400 - Pos.: 13, 25, 26, 44, 53, 63, 77, 79, 80, 118, 121, 129, 136, 149, 153, 283

²⁾ quantité nécessaire / entretien

H INDICE	Pos.	No. Identificazione	Designazione	IT	
U 4.250	□	549000 26400	SERIE DI GUARNIZIONE ¹⁾		
	1	000102 26500	CARCASSA		
	3	020000 26500	ROTORE		
	5	900507 00003	PALETTE IN PLASTICA (KIT) ²⁾		
	7	917611 00000	ANELLO DI TENUTA DEL CUSCINETTO		
	8	911472 00000	DISCO DISTANZA		
	9	906662 00000	CUSCINETTO 6207 DIN 625		
	10	906576 00000	GUARNIZIONE PER L'ALBERO		
	11	912820 00000	COPERCHIO		
	15	000801 26500	COPERCHIO		
	16	000702 26500	COPERCHIO		
	18	902108 00000	GIUNTO		
	19	902210 00000	DISCO GUINTO		
	21	945331 00000	VITE ESAGONALE INTERNA		
	22	948742 00000	PERNO		
	24	947733 00000	CHIAVETTA		
	30	502301 26400	VENTILATORE		
	31	947732 00000	CHIAVETTA		
	32	945270 00000	VITE DI CHIUSURA ALBERO		
	33	949409 00000	RONDELLA		
	39	053200 26500	FLANGIA DI RACCORDE		
	40	945321 00000	VITE ESAGONALE INTERNA		
	41	537502 26400	VALVOLA NON RITORNO, INTERO		
	46	008002 26400	FILTRO		
	47	945371 00000	VITE ESAGONALE INTERNA		
	49	951602 00000	GOLFARE CON FORO FILETTATO		
	50	946969 00000	L'ASTA A VITE		
	52	951228 00000	VITE DI CHIUSURA		
	61	002410 26400	CARCASSA SEPARATORE OLIO		
	62	951221 00100	VITE DI CHIUSURA		
	64	001703 26400	COPERCHIO SERBATOIO OLIO		
	67	003705 26400	COPERCHIO		
	69	946968 00000	L'ASTA A VITE		
	70	917107 00000	RONDELLA A MOLLA		
	71	947105 00000	DADO ESAGONALE		
	74	305800 02000	DADO DI RISVOLTO		
	76	727505 99628	SILENZIATORE		
	82	537502 26200	VALVOLA, INTERO		
	83	965415 00000	CARTUCCIA SEPARATORE OLIO (2x) ²⁾		
	89	921500 50000	MANETTA		
	90	013301 26400	FILTRO METALICO		
	91	945318 00000	VITE ESAGONALE INTERNA		
	94	867800 99559	GALLEGGIANTE		
	95	003300 10700	UGELLO		
	98	912871 00000	VITE DI CHIUSURA		
	101	506000 26400	SEPARATORE GROSSOLANO		
	104	008003 26400	FILTRO		
	105	952014 00000	MANICOTTO DI FISSAZIONE		
	112	003703 26400	COPERCHIO		
	119	907309 00000	SPIA LIVELLO OLIO		
	120	916800 10000	COPERCHIO		
	124	947104 00000	DADO ESAGONALE		
	125	948504 00000	ANELLO A MOLLA		
	126	951001 02000	L'ASTA A VITE		
	128	951003 02000	L'ASTA A VITE		
	130	945383 00000	VITE ESAGONALE INTERNA		
	131	945230 00000	VITE ESAGONALE		
	132	945363 00000	VITE ESAGONALE INTERNA		
	133	945321 00000	VITE ESAGONALE INTERNA		

H INDICE	Pos.	No. Identificazione	Designazione	IT	
	134	945324 00000	VITE ESAGONALE INTERNA		
	135	951220 00100	VITE DI CHIUSURA		
	141	012223 26400	CONDOTTO		
	143	012221 26400	CONDOTTO OLIO		
	144	012224 26400	CONDOTTO		
	148	948402 00000	VITE ESAGONALE		
	152	009400 19000	VITE PASSAGGIO OLIO		
	154	012900 19000	VITE DI CHIUSURA		
	156	912306 00000	ATTACO FILETTATO		
	157	960201 26400	RAFFREDDATORE		
	159	012222 26400	CONDOTTO		
	181	018301 26400	CARTER DI PROTEZIONE		
	184	945127 00000	VITE ESAGONALE		
	185	947506 00000	RONDELLA		
	186	947106 00000	DADO		
	187	568100 26400	SUPPORTO		
	188	949408 00000	RONDELLA		
	190	945227 00000	VITE		
	193	949203 00000	DISCO A DENTE		
	197	741302 00000	AMMORTIZZATORE IN GOMMA		
	198	945634 00000	SPINA FILETTATURA		
	214	950700 10000	SCATOLA DEI CONNETTORI		
	215	946304 00000	VITE ESAGONALE INTERNA		
	216	943400 90000	TASTATORE TEMPERATURE		
	218	902100 21900	GIUNTO MOTORE Ø38MM		
	282	741103 99682	SONDA D'OLIO - OPTIONALE		
	313	902100 21300	GIUNTO MOTORE (US)		
	314	945238 00000	VITE ESAGONALE (US)		
	316	037900 10400	FLANGE INTERMEDIA (US)		
	406	768705 99626	VALVOLA DI ZAVORATRICE - OPTIONALE		
		960009 00200	BECKER LUBE M 100 (OLIO MINERALE) - 5L		
		960016 00200	BECKER LUBE S 100 (OLIO SINTETICO) - 5L		
		960023 00200	BECKER LUBE SL 100 (SETTORE ALIMENTARE) - 5L		

¹⁾ Serie di guarnizione - 549000 26400 - Pos.: 13, 25, 26, 44, 53, 63, 77, 79, 80, 118, 121, 129, 136, 149, 153, 283

²⁾ quantità di ordinazione necessari / manutenzione

H INDICE	Pos.	No. De pedido	Descripción	
U 4.250	□	549000 26400	JUNTA COMPLETA ¹⁾	
	1	000102 26500	CARCASA	
	3	020000 26500	ÉMBOLO	
	5	900507 00003	EMPUJADOR DE PLÁSTICO (KIT) ²⁾	
	7	917611 00000	ANILLO DE COJINETE DE JUNTA	
	8	911472 00000	ARANDELA DISTANCIADORA	
	9	906662 00000	COJINETE DE RODAMIENTO 6207 DIN 625	
	10	906576 00000	ANILLO DE JUNTA DE ÁRBOL	
	11	912820 00000	TAPA DE CIERRE	
	15	000801 26500	TAPA LATERAL	
	16	000702 26500	TAPA LATERAL	
	18	902108 00000	MITAD DE ACOPLAMIENTO	
	19	902210 00000	DISCO DE ACOPLAMIENTO	
	21	945331 00000	TORNILLO HEXAGONAL INTERIOR	
	22	948742 00000	PASADOR ENTALLADO DE AJUSTE	
	24	947733 00000	LENGÜETA DE AJUSTE	
	30	502301 26400	VENTILADOR CON CUBO	
	31	947732 00000	LENGÜETA DE AJUSTE	
	32	945270 00000	TORNILLO TERMINAL DE ÁRBOL	
	33	949409 00000	ARANDELA	
	39	053200 26500	FAROL	
	40	945321 00000	TORNILLO HEXAGONAL INTERIOR	
	41	537502 26400	VÁLVULA ANTIRRETORNO COMPLETA	
	46	008002 26400	CRIBA	
	47	945371 00000	TORNILLO HEXAGONAL INTERIOR	
	49	951602 00000	TUERCA DE CÁNCAMO	
	50	946969 00000	ESPÁRRAGO	
	52	951228 00000	TORNILLO DE CIERRE	
	61	002410 26400	CARCASA SEPARADORA	
	62	951221 00100	TORNILLO DE CIERRE	
	64	001703 26400	TAPA DE RECIPIENTE DE ACEITE	
	67	003705 26400	TAPA	
	69	946968 00000	ESPÁRRAGO	
	70	917107 00000	ARANDELA DE APOYO DEL RESORTE	
	71	947105 00000	TUERCA HEXAGONAL	
	74	305800 02000	SOBRETUERCA	
	76	727505 99628	VÁLVULA DE BARRIDO	
	82	537502 26200	VÁLVULA COMPLETA	
	83	965415 00000	ELEMENTO DE DESACEITAR DE AIRE (2x) ²⁾	
	89	921500 50000	EMPUÑADURA	
	90	013301 26400	CHAPA DE REBOTE	
	91	945318 00000	TORNILLO HEXAGONAL INTERIOR	
	94	867800 99559	FLOTADOR	
	95	003300 10700	TOBERA	
	98	912871 00000	TORNILLO DE CIERRE	
	101	506000 26400	SEPARADOR DE SÓLIDOS GRUESOS COMPLETO	
	104	008003 26400	CRIBA	
	105	952014 00000	MANGUITO DE FIJACIÓN	
	112	003703 26400	TAPA	
	119	907309 00000	CRISTAL MIRILLA DE ACEITE	
	120	916800 10000	TAPA ROSCADA	
	124	947104 00000	TUERCA HEXAGONAL	
	125	948504 00000	ARANDELA DE MUELLE	
	126	951001 02000	ESPÁRRAGO	
	128	951003 02000	ESPÁRRAGO	
	130	945383 00000	TORNILLO HEXAGONAL INTERIOR	
	131	945230 00000	TORNILLO HEXAGONAL	
	132	945363 00000	TORNILLO HEXAGONAL INTERIOR	
	133	945321 00000	TORNILLO HEXAGONAL INTERIOR	







H INDICE	Pos.	No. De pedido	Descripción	
	134	945324 00000	TORNILLO HEXAGONAL INTERIOR	
	135	951220 00100	TORNILLO DE CIERRE	
	141	012223 26400	CONDUCTO	
	143	012221 26400	CONDUCTO DE RETROALIMENTACIÓN DE ACEITE	
	144	012224 26400	CONDUCTO	
	148	948402 00000	TORNILLO HUECO	
	152	009400 19000	TORNILLO DE PIEZA ESFÉRICA	
	154	012900 19000	TORNILLO DE CIERRE	
	156	912306 00000	TORNILLO DE EMPALME	
	157	960201 26400	REFRIGERADOR	
	159	012222 26400	CONDUCTO	
	181	018301 26400	SOMBRETERE	
	184	945127 00000	TORNILLO DE CABEZA HEXAGONAL	
	185	947506 00000	ARANDELA	
	186	947106 00000	TUERCA	
	187	568100 26400	APOYO	
	188	949408 00000	ARANDELA	
	190	945227 00000	TORNILLO TERMINAL DE ÁRBOL	
	193	949203 00000	POLEA DENTADA	
	197	741302 00000	AMORTIGUADOR DE GOMA	
	198	945634 00000	VARILLA ROSCADA	
	214	950700 10000	CAJA DE CONEXIÓN	
	215	946304 00000	TORNILLO HEXAGONAL INTERIOR	
	216	943400 90000	SENSOR DE TEMPERATURA	
	218	902100 21900	ACOPAMIENTO DE MOTOR Ø38MM	
	282	741103 99682	GENERADOR DE NIVEL - OPCIONAL	
	313	902100 21300	ACOPAMIENTO DE MOTOR (US)	
	314	945238 00000	TORNILLO DE CABEZA HEXAGONAL (US)	
	316	037900 10400	BRIDA INTERMEDIA (US)	
	406	768705 99626	VÁLVULA DE LASTRE DE GAS - OPCIONAL	
		960009 00200	BECKER LUBE M 100 (ACEITE MINERAL) - 5L	
		960016 00200	BECKER LUBE S 100 (ACEITE SINTÉTICO) - 5L	
		960023 00200	BECKER LUBE SL 100 (SECTOR ALIMENTARIO) - 5L	

¹⁾ Junta completa - 549000 26400 - Pos.: 13, 25, 26, 44, 53, 63, 77, 79, 80, 118, 121, 129, 136, 149, 153, 283

²⁾ cantidad necesario / mantenimiento

U 4.250	Variante 	Pos. ²⁾	Bestell Nr. / Ident No. / No. Identification / No. Identificazione / No. De pedido		Beschreibung / Description / Designation / Designazione / Desripcion
① U 4.250 F/K		96	003301 30000		DÜSE / NOZZLE / GICLEUR / UGELLO / TOBERA
		97	912300 00000		ANSCHLUSSSCHRAUBE / CONNECTING SCREW / VIS DE RACCORD / ATTACO FILETTATO / TORNILLO DE EMPALME
		98		942874-00000	VERSCHLUSSSCHRAUBE / LOCKING SCREW / BOUCHON / VITE DI CHIUSURA / TORNILLO DE CIERRE
		151	012227 26400		LEITUNG / OIL SUCTION PIPE / TUYAU D'HUILE / CONDOTTO OLIO / CONDUCTO DE ASPIRACIÓN DE ACEITE
		152	009400 19000		KUGELSTÜCKSCHRAUBE / HOLLOW HOLDING SCREW / VIS CREUSE DE FIXATION / VITE PASSAGGIO OLIO / TORNILLO DE PIEZA ESFÉRICA
		153	948002 00000		DICHTUNG / GASKET / JOINT / GUARNIZIONE / JUNTA
		154		042900-19000	VERSCHLUSSSCHRAUBE / LOCKING SCREW / BOUCHON / VITE DI CHIUSURA / TORNILLO DE CIERRE
		233	537503 26400		VENTIL, KOMPL. / VALVE, ENTIRE / SOUPAPE, ENTIER / VALVOLA, INTERO / VÁLVULA COMPLETA
② U 4.250 SA/K-25 ③ U 4.250 F/K-25 - nur mit ÖL-Wasser-Kühler - only with oil-to-water heat exchanger - avec réfrigérant à l'huile et à l'eau - con radiatore ad olio - acqua - con refrigerador aceite-agua		91		945318-00000	INNENSECHSKANTSCHRAUBE / ALLEN SCREW / VIS ALLEN / VITE ESAGONALE INTERNA / TORNILLO HEXAGONAL INTERIOR
		141	012213 26400	042223-26400	LEITUNG / PIPE / TUYAU / CONDOTTO / CONDUCTO
		142	012225 26400		LEITUNG / PIPE / TUYAU / CONDOTTO / CONDUCTO
		144	012212 26400	042216-26400	LEITUNG / PIPE / TUYAU / CONDOTTO / CONDUCTO
		146	012226 26400		LEITUNG / PIPE / TUYAU / CONDOTTO / CONDUCTO
		157		960204-26400	KUEHLER / COOLER / REFROIDISSEUR / RAFFREDDATORE / REFRIGERADOR
		159		042222-26400	LEITUNG / PIPE / TUYAU / CONDOTTO / CONDUCTO
		181	018304 26400	048304-26400	HAUBE / PROTECTING HOOD / CARTER PROTECTEUR / CARTER DI PROTEZIONE / SOMBRERETE
		193		949203-00000	ZAHNSCHEIBE / TOOTHED LOCK WASHER / RONDELLE À DENTS / RONDELLA DENTATA / ARANDELA DENTADA
		203	960204 26200		KÜHLER / COOLER / REFROIDISSEUR / RAFFREDDATORE / REFRIGERADOR
		204	969438 00000		L-VERSCHRAUBUNG / L-PIECE / L-PIECE / PEZZO A L / ATORNILLADURA
		205	935200 10000		VERLÄNGERUNG / ADAPTOR / RACCORD INTERMÉDIAIRE / RACCORDO INTERMEDIO / ADAPTADOR
		206	969401 00009		SCHLAUCH / FLEXIBLE HOSE / TUYAUTERIE FLEXIBLE / TUBAZIONE FLESSIBILE / TUBERÍA FLEXIBLE
209	922401 20000		SCHUTZGITTER / SAFETY GUARD / GRILLAGE DE PROTECTION / GABBIA DI PROTEZIONE / REJILLA DE PROTECCIÓN		
④ U 4.250 SA/K-25.1 ⑤ U 4.250 F/K-25.1 - mit zusätzlichem ÖL-Wasser-Kühler - with additional oil-to-water heat exchanger - avec réfrigérant à l'huile et à l'eau - con radiatore ad olio - acqua - con refrigerador aceite-agua		141	012213 26400	042223-26400	LEITUNG / PIPE / TUYAU / CONDOTTO / CONDUCTO
		142	012225 26400		LEITUNG / PIPE / TUYAU / CONDOTTO / CONDUCTO
		144	012212 26400		LEITUNG / PIPE / TUYAU / CONDOTTO / CONDUCTO
		146	012217 26400		LEITUNG / PIPE / TUYAU / CONDOTTO / CONDUCTO
		181		048304-26400	HAUBE / PROTECTING HOOD / CARTER PROTECTEUR / CARTER DI PROTEZIONE / SOMBRERETE
		203	960204 26200		KÜHLER / COOLER / REFROIDISSEUR / RAFFREDDATORE / REFRIGERADOR
		204	969438 00000		L-VERSCHRAUBUNG / L-PIECE / L-PIECE / PEZZO A L / ATORNILLADURA
		205	935200 10000		VERLÄNGERUNG / ADAPTOR / RACCORD INTERMÉDIAIRE / RACCORDO INTERMEDIO / ADAPTADOR
		206	969401 00009		SCHLAUCH / FLEXIBLE HOSE / TUYAUTERIE FLEXIBLE / TUBAZIONE FLESSIBILE / TUBERÍA FLEXIBLE
		208	018303 26400		HAUBE / PROTECTING HOOD / CARTER PROTECTEUR / CARTER DI PROTEZIONE / SOMBRERETE

²⁾ variantenabhängige Bauteile / variant-dependent components / composants variante-dependantes / componenti variante-dispendenti / componentes variante-dependientes

U 4.250	Variante 	Pos. ²⁾	Bestell Nr. / Ident No. / No. Identification / No. Identificazione / No. De pedido		Beschreibung / Description / Designation / Designazione / Desripcion	
			  	  		
⑥ U 4.250 SA/K-51 ⑦ U 4.250 F/K-51 - mit Ölbadheizung, Niveau-Geber und Thermostat - with oil bath heating, level transmitter and heat valve - avec chauffage du bain d'huile, capteur de niveau et thermostat - con riscaldamento a bagno d'olio, indicatore di livello e termostato - con calefacción de baño de aceite, codificador de nivel y termostato		61		002410 26400	ÖLABSCHEIDERGEHÄUSE / HOUSING FOR OIL SEPARATION / CARCASSE POUR SEPARATION D'HUILLE / CARCASSA SEPARATORE OLIO / CARCASA SEPARADORA DE ACEITE	
		62		951221 00000	VERSCHLUSSSCHRAUBE / LOCKING SCREW / BOUCHON / VITE DI CHIUSURA / TORNILLO DE CIERRE	
		282	741103 99682			NIVEAUGEBER / LEVEL TRANSMITTER / CAPTEUR DE NIVEAU / INDICATORE DI LIVELLO / CODIFICADOR DE NIVEL
		283	948086 00000			DICHTRING / SEALING RING / JOINT / ANELLO / ANILLO
		340	002412 26400			ÖLABSCHEIDERGEHÄUSE / HOUSING FOR OIL SEPARATION / CARCASSE POUR SEPARATION D'HUILLE / CARCASSA SEPARATORE OLIO / CARCASA SEPARADORA DE ACEITE
		341	960202 26400			ROHRHEIZKÖRPER / PIPE HEATER / CORPS DE CHAUFFE / SCALDIGLIA / CALEFACTOR TUBULAR
		342	943400 70000			TEMPERATUR-WÄCHTER / THERMOSTAT / THERMOSTAT / INTERRUPTORE TERMICO / TERMOSTATO
		343	948070 00000			KUPFERRING / SEALING RING / JOINT / ANELLO / ANILLO DE COBRE
		344	913116 00100			O-RING / O-RING SEAL / JOINT TORIQUE / GIUNTO CILINDRICO DI TENUTA / JUNTA TOROIDAL
		345	948011 00000			DICHTRING / SEALING RING / JOINT / ANELLO / ANILLO
⑧ U 4.250 SA/K-54 - mit zusätzlicher Ölablassbohrung - with additional oil draining bore hole - avec trou de vidange d'huile - con foro di scarico dell'olio aggiuntivo - con perforación de salida de aceite adicional		61		002410 26400	ÖLABSCHEIDERGEHÄUSE / HOUSING FOR OIL SEPARATION / CARCASSE POUR SEPARATION D'HUILLE / CARCASSA SEPARATORE OLIO / CARCASA SEPARADORA DE ACEITE	
		361	002411 26400			ÖLABSCHEIDERGEHÄUSE / HOUSING FOR OIL SEPARATION / CARCASSE POUR SEPARATION D'HUILLE / CARCASSA SEPARATORE OLIO / CARCASA SEPARADORA DE ACEITE
		363	951220 00100			VERSCHLUSSSCHRAUBE / LOCKING SCREW / BOUCHON / VITE DI CHIUSURA / TORNILLO DE CIERRE

²⁾ variantenabhängige Bauteile / variant-dependent components / composants variante-dependantes / componenti variante-dispendenti / componentes variante-dependientes